

OCT. 1923  
BRISTOW  
OKLA.

W. 9TH 4 AV.

E. 9TH AV.

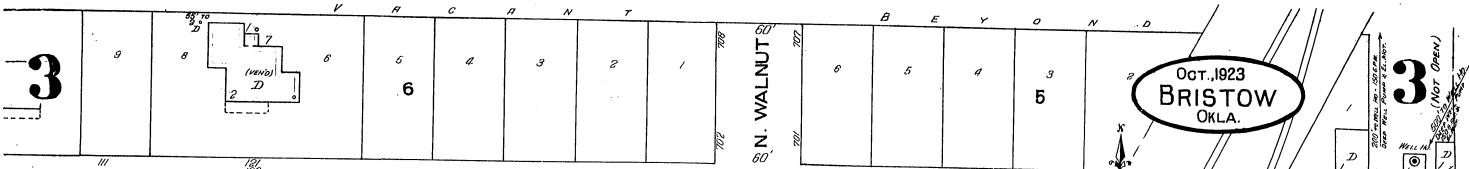

E. 12<sup>TH</sup> AV.

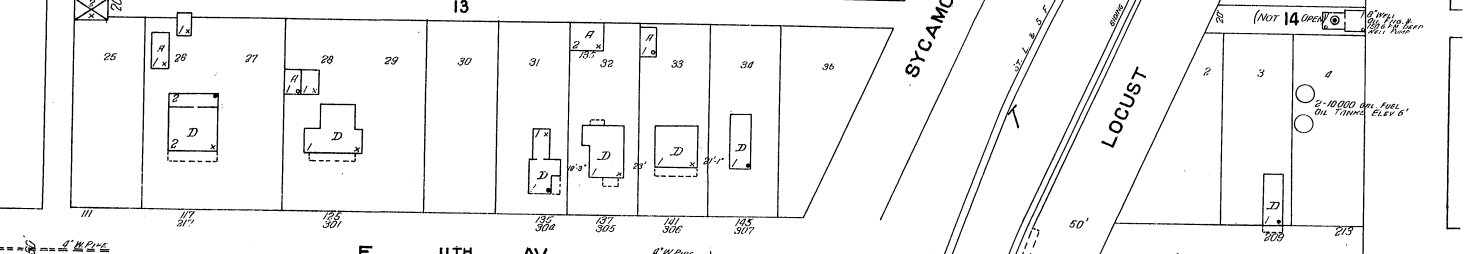
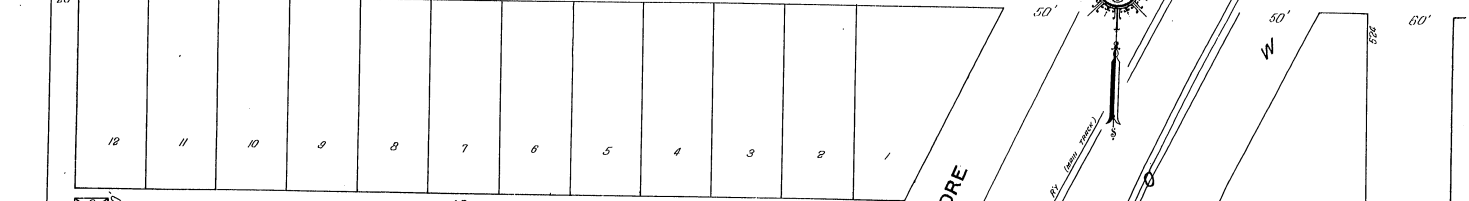

E. 11<sup>TH</sup> AV.

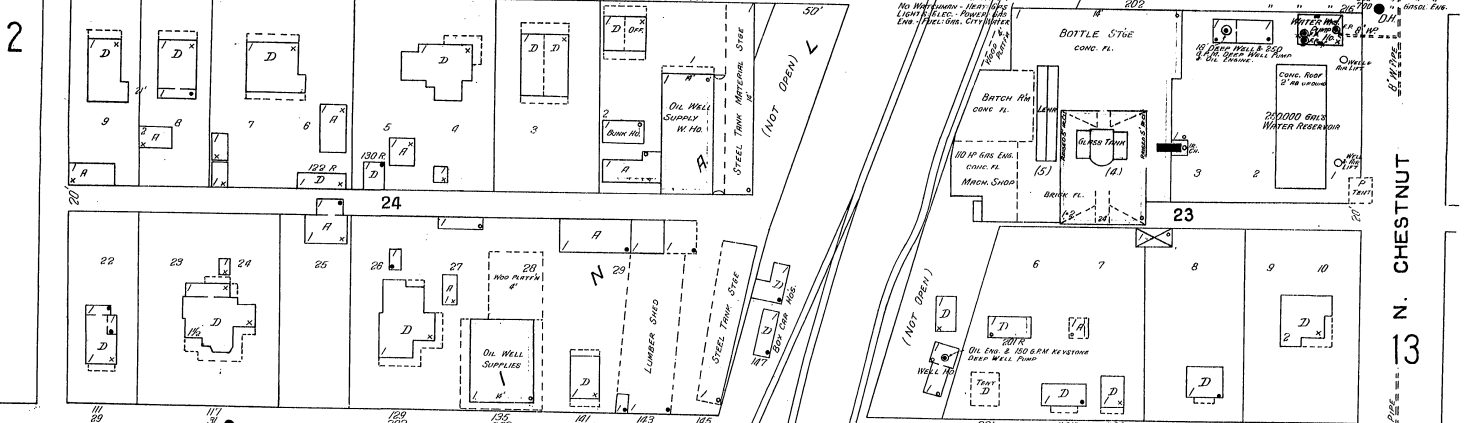

E. 10<sup>TH</sup> AV.

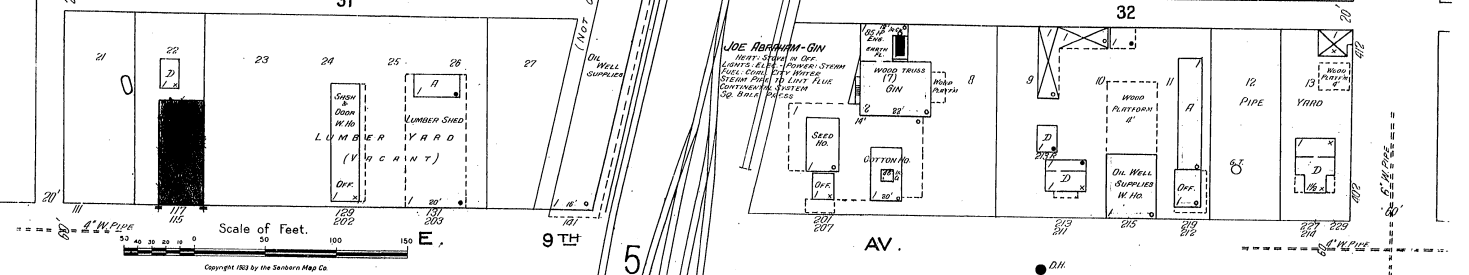
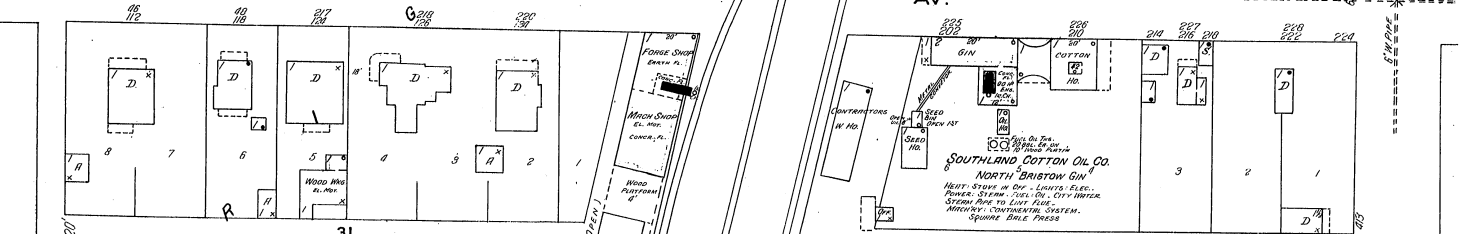

E. 9<sup>TH</sup> AV.



Scale of Feet. 0 50 100 150

Copyright 1923 by the Seaborn Map Co.

OCT. 1923  
BRISTOW  
OKLA.

4

4

2

W. 9TH

AV.

E. 9TH

AV.

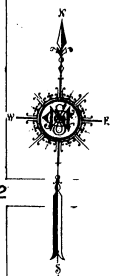
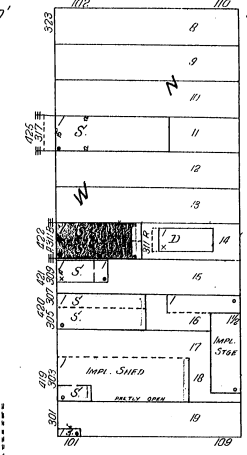
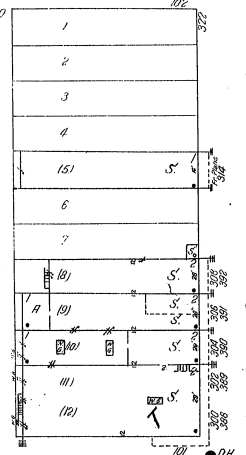
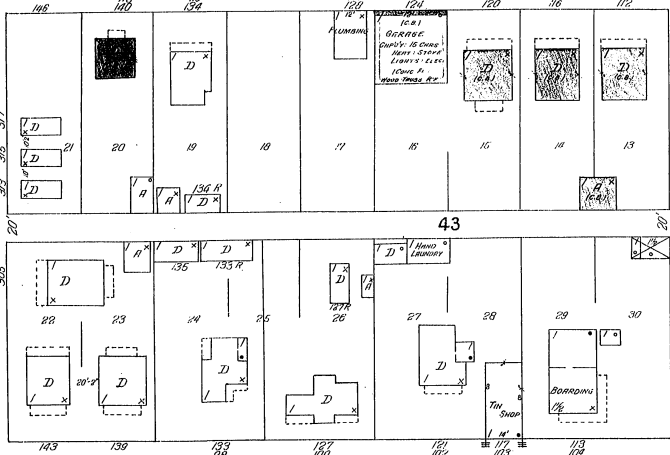

10

W. 8TH

AV.

E. 8TH

AV.

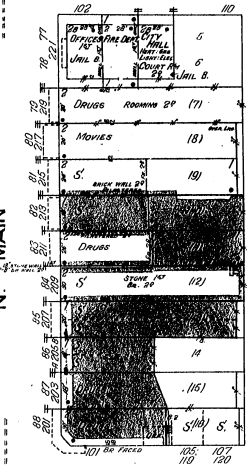
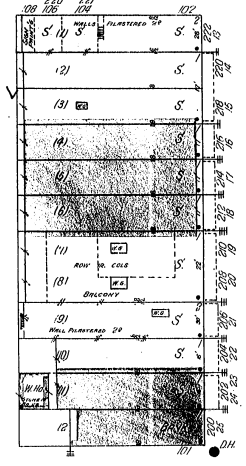
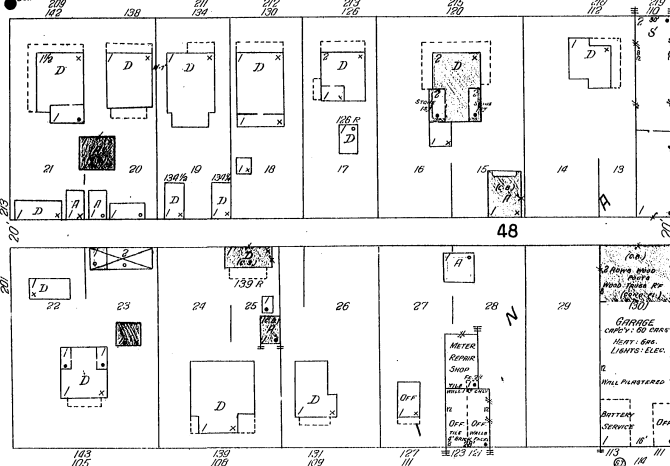

5

N. ELM

N. MAIN

11

W. 7TH

AV.

E. 7TH

AV.

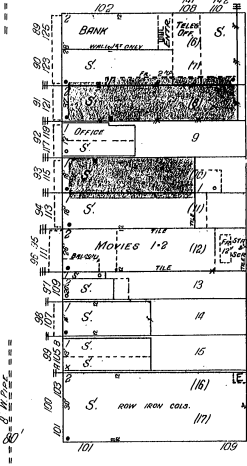
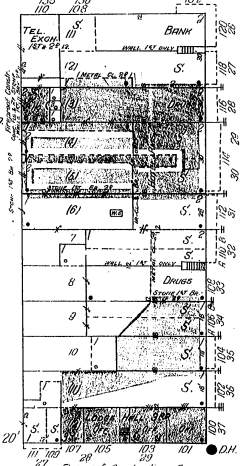
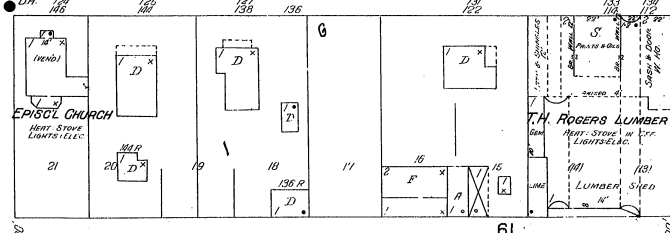

60

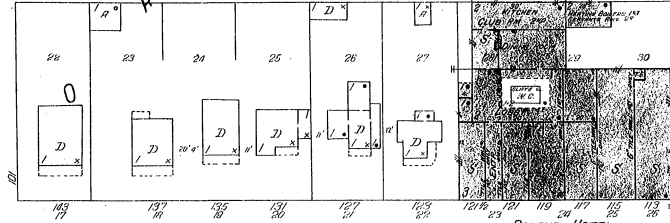

W. 6TH

AV.

E. 6TH

AV.

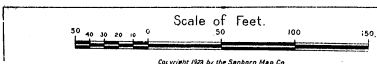

6

Copyright 1923 by the Searson Map Co.

OCT. 1923  
BRISTOW  
OKLA.

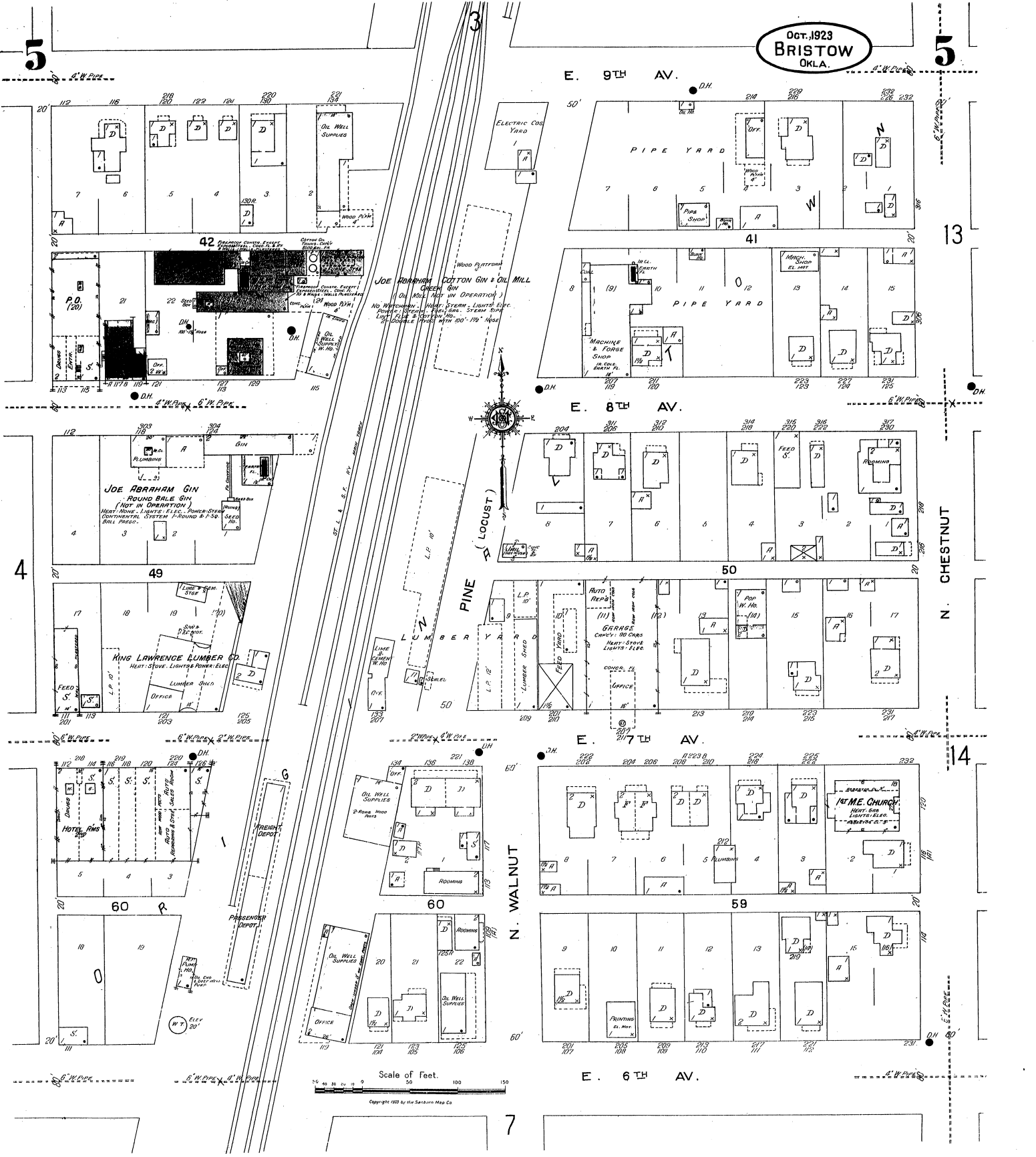

Scale of Feet.  
0 25 50 75 100 150  
Copyright 1923 by the Searborn Map Co.

JOE ABRAHAM  
GREEN GIN  
(OIL MILL STOP IN OPERATION)  
NO. WYOMING 1. HULL. SCREW. LIGHTS. ELEC. ETC.  
POWER. STEAM. STEAM. STEAM. STEAM. STEAM. STEAM.  
L.P. DOUBLE WHEEL WITH 100-110" WHEEL

JOE ABRAHAM GIN  
ROUND BALE GIN  
(NOT IN OPERATION)  
HEAT. MOVE. LIGHTS. ELEC. POWER STEAM  
CONTINENTAL SYSTEM. FORWARD & REAR  
BALL PRESS.

KING LAWRENCE LUMBER CO.  
HEAT. STOVE. LIGHTS. BONGS. ELEC.

M. E. CHURCH  
HEAT. GAS  
LIGHTS. ELEC.  
MACHINE & FORGE

PIPE YARD

MACHINE & FORGE  
SHED

AUTO REPAIR  
GARAGE  
CHECK. 100 CARS  
HEAT. STOVE  
LIGHTS. ELEC.

OIL WELL SUPPLIES  
2 ROOMS. HOOD  
PRESS

OIL WELL SUPPLIES

OIL WELL SUPPLIES

PRINTING  
EL. MACH.



(LOCUST)

N. WALNUT

N. CHESTNUT

E. 6TH AV.

E. 8TH AV.

E. 9TH AV.

5' W. PINE

4' W. PINE

4' W. PINE

4' W. PINE

6' W. PINE

6' W. PINE

6' W. PINE

6' W. PINE

4

5

13

14

7

W. 6TH AV.

E. 6TH AV.

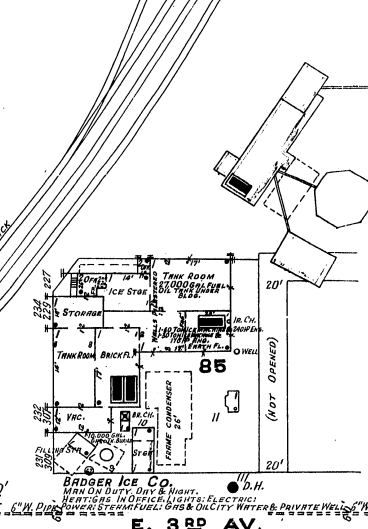
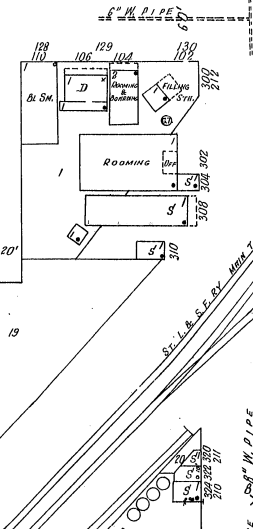
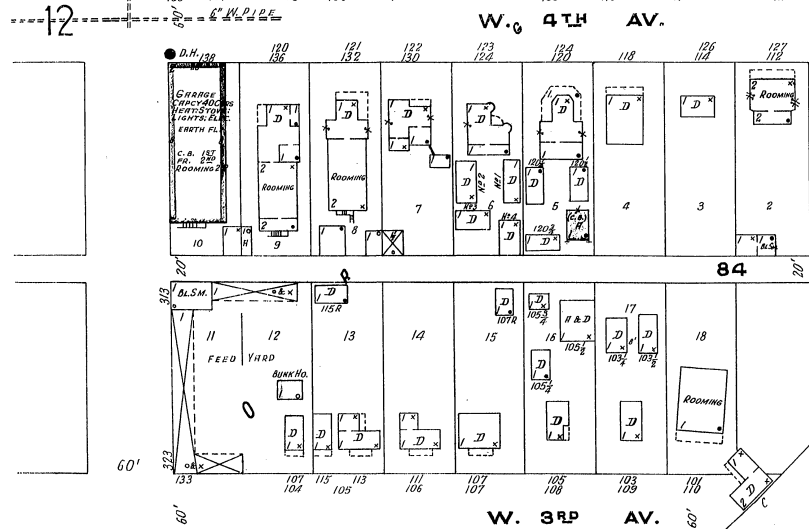
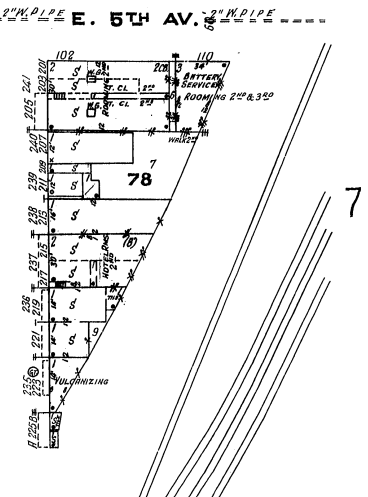
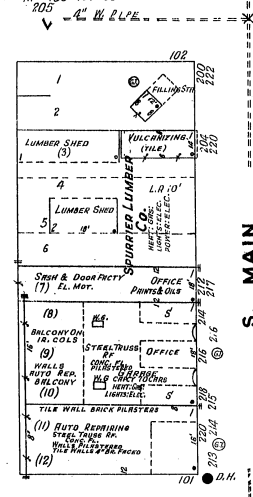
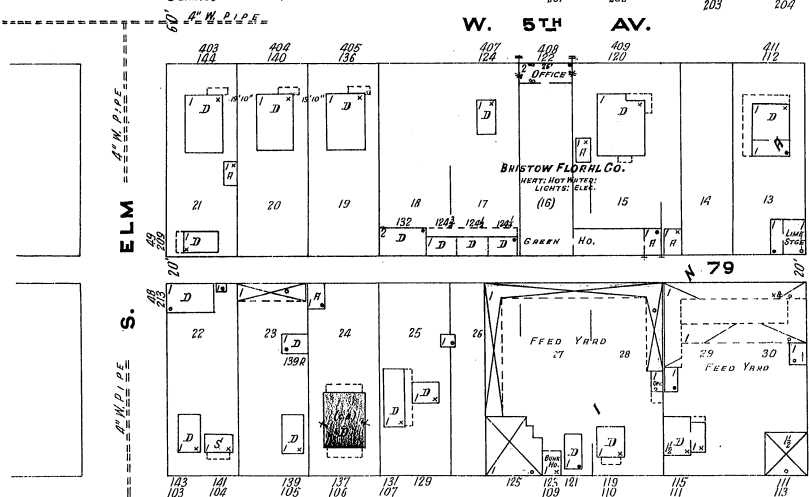
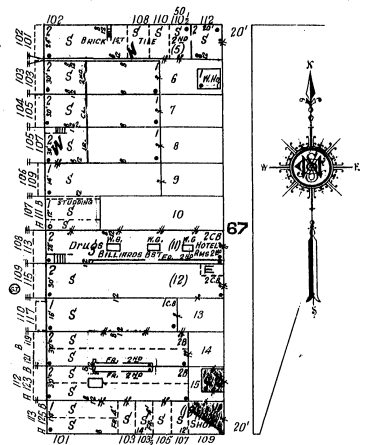
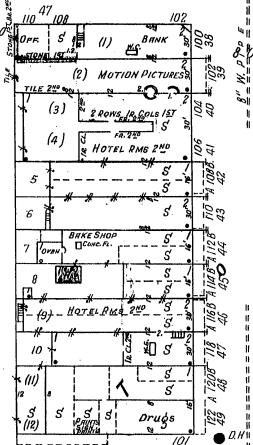
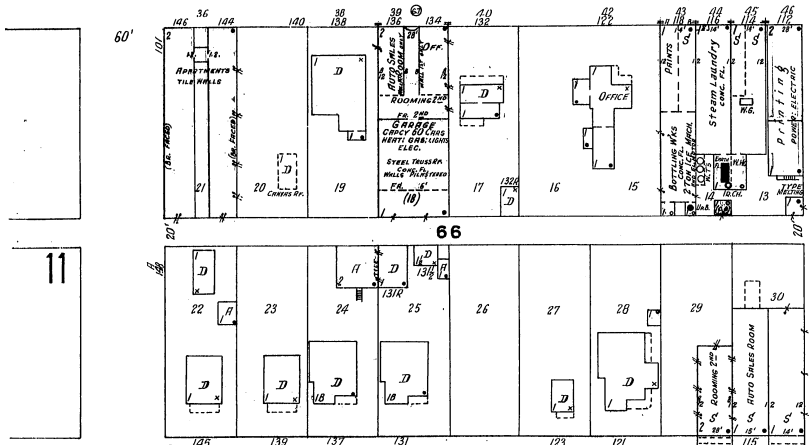

W. 3RD AV.

E. 3RD AV.

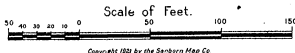

Copyright 1923 by the Sanborn Map Co.

7

5

OCT., 1923  
BRISTOW  
OKLA.

E. 6TH AV.

7

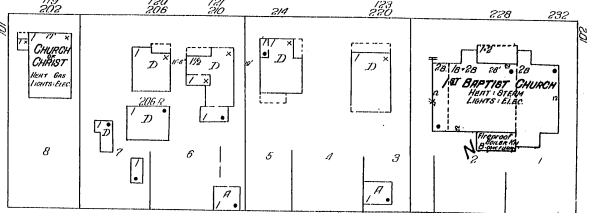
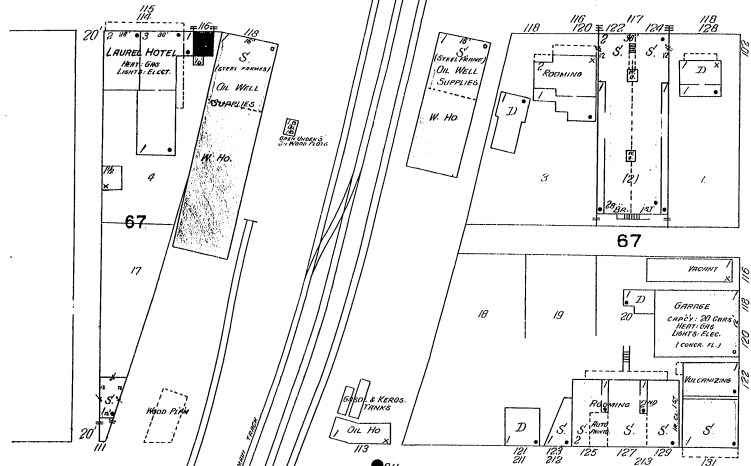

14

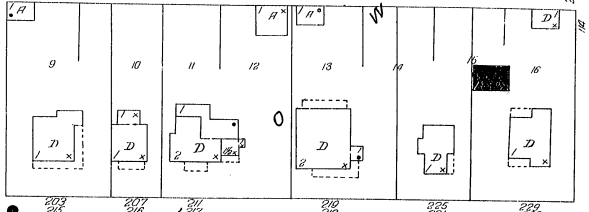
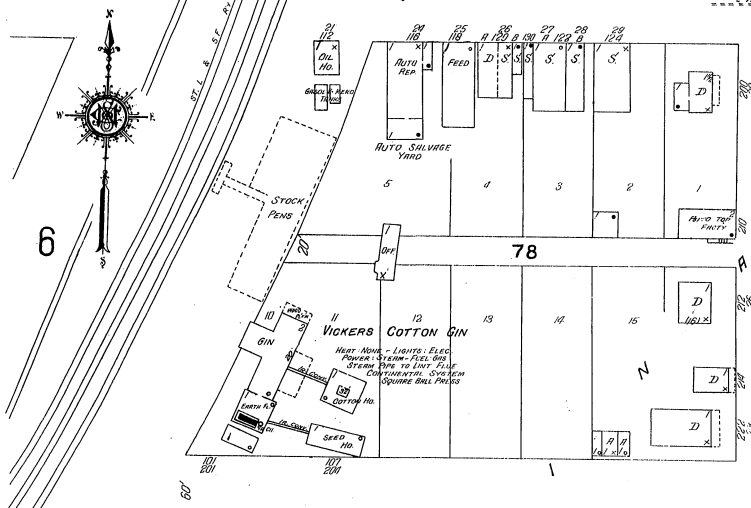

E. 5TH AV.

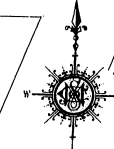

6

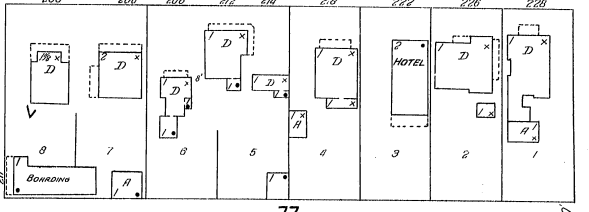

S. WALNUT

S. CHESTNUT

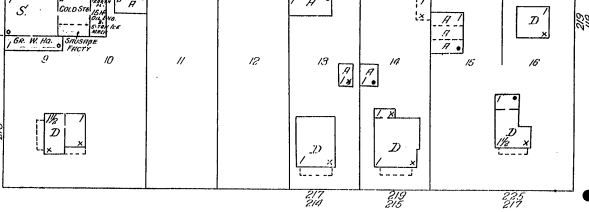
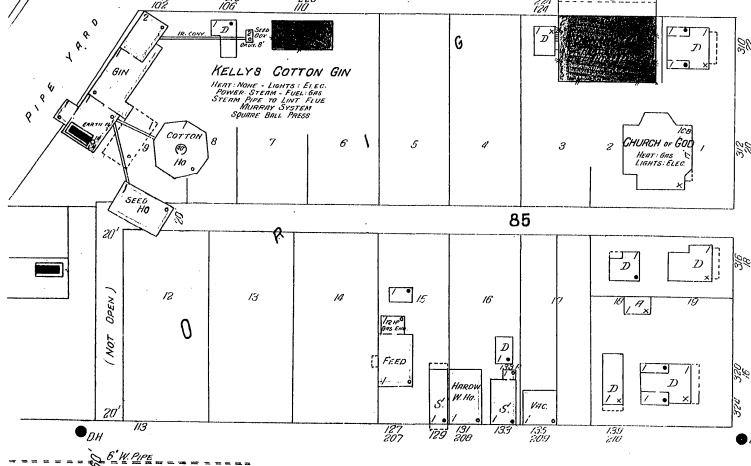

E. 4TH AV.

15

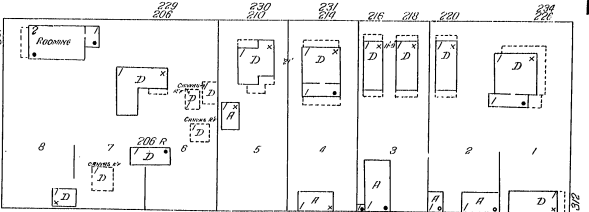
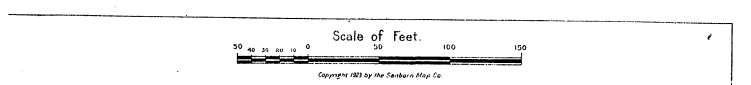

E. 3RD AV.

9

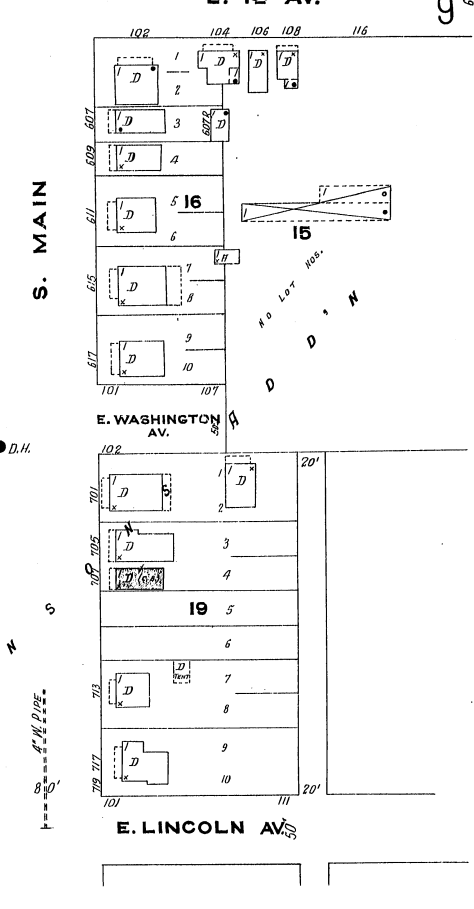
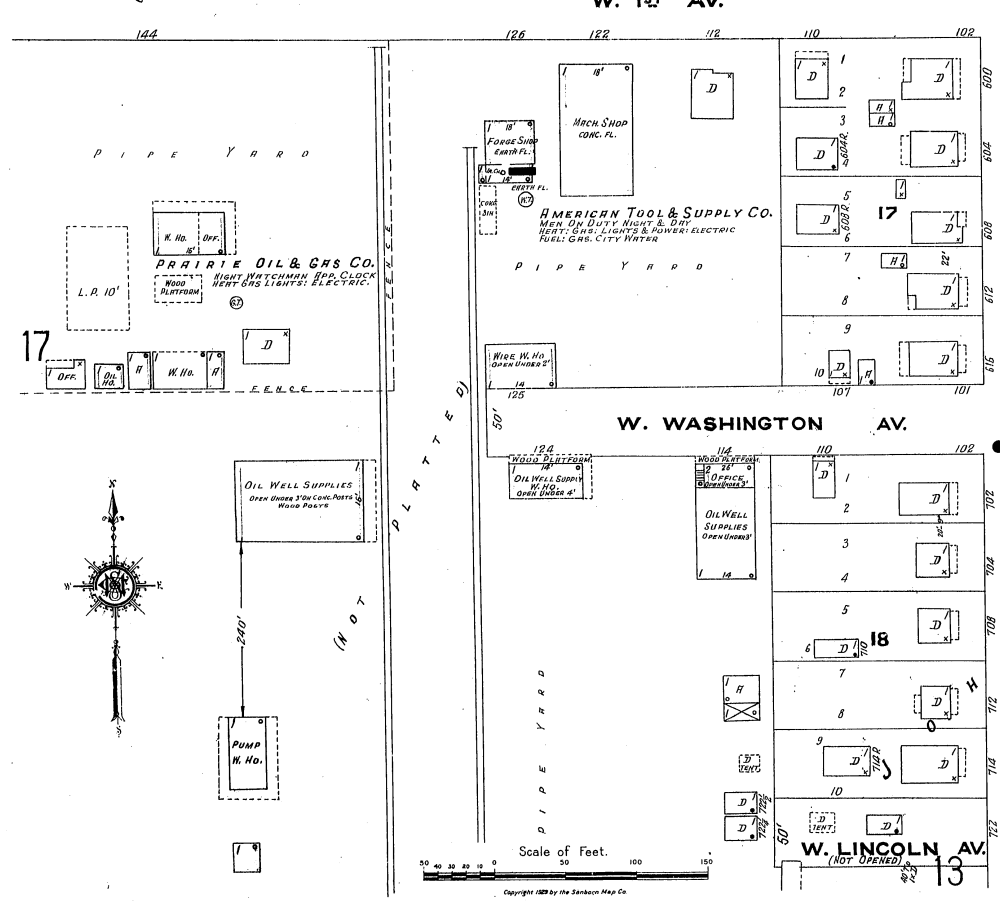
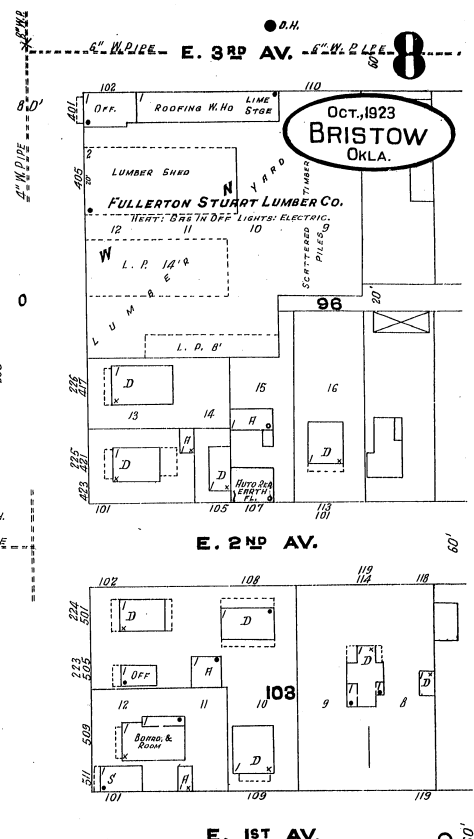
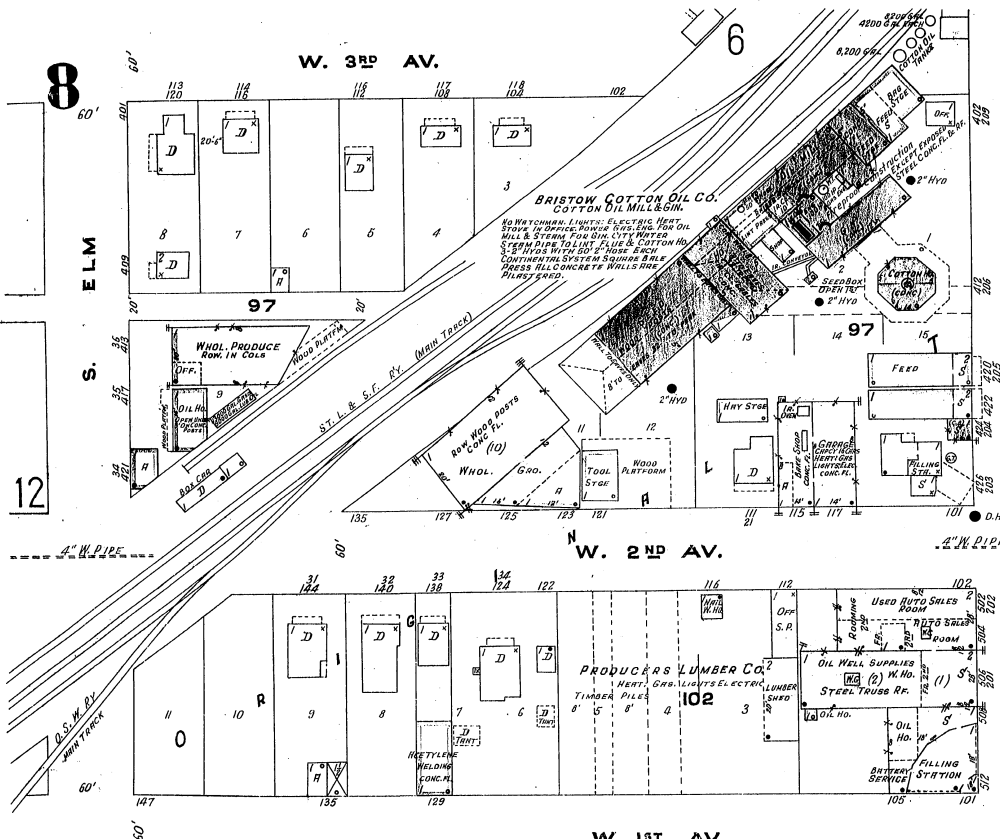

Oct., 1923  
 BRISTOW  
 OKLA.



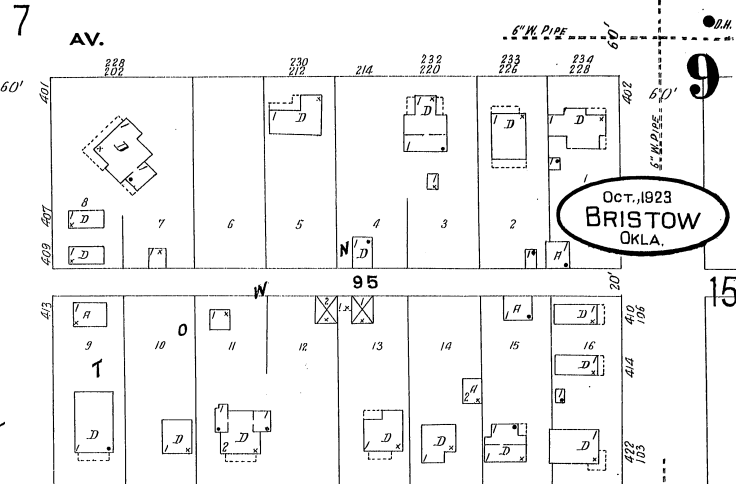
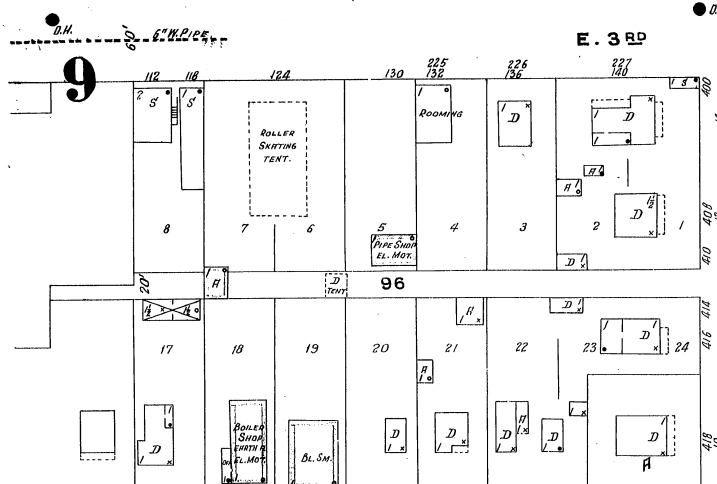

Oct., 1923  
BRISTOW  
OKLA.

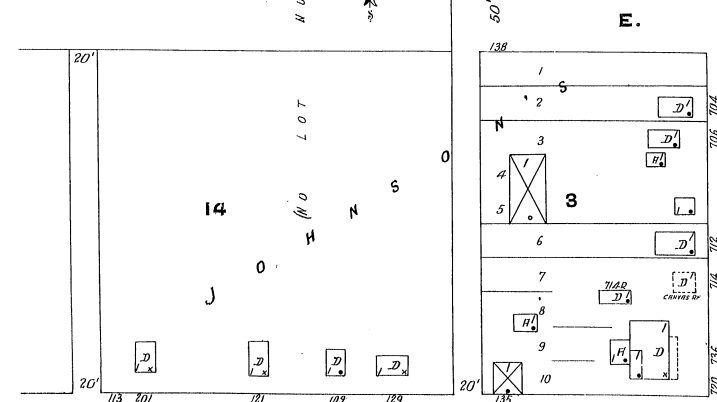
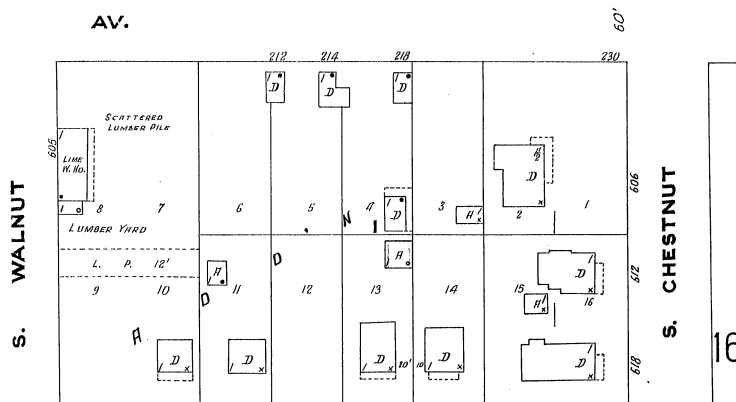
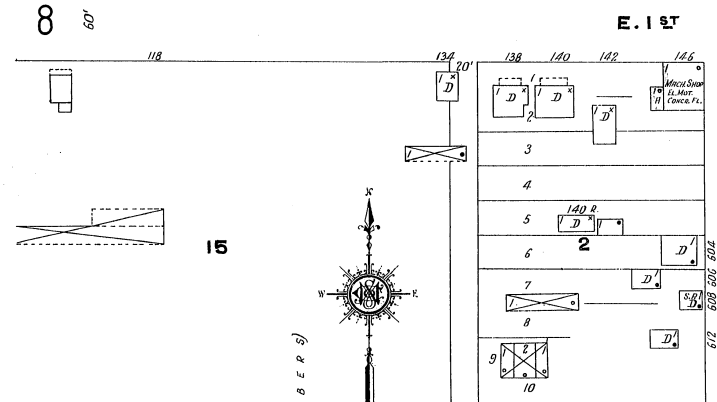
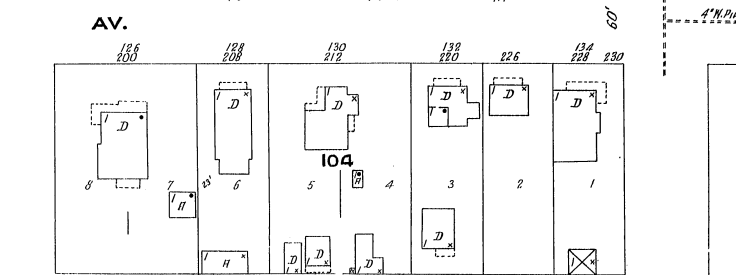
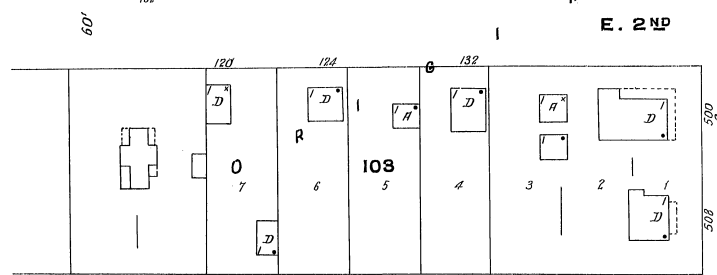

Scale of Feet.  
0 10 20 30 40 50 60 70 80 90 100  
Copyright 1923 by the Sanborn Map Co.

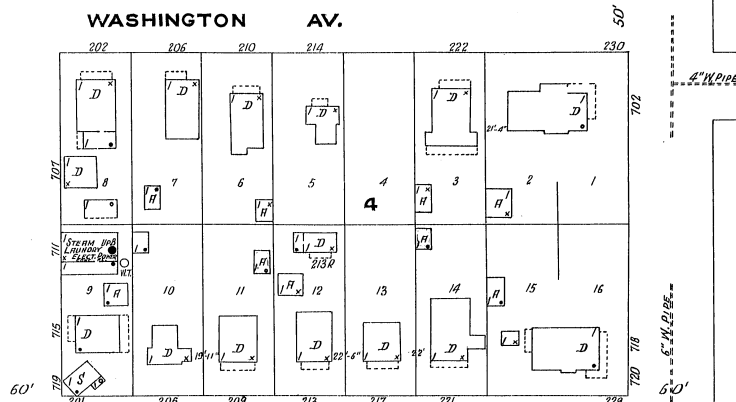

Oct., 1923  
BRISTOW  
OKLA.

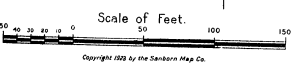
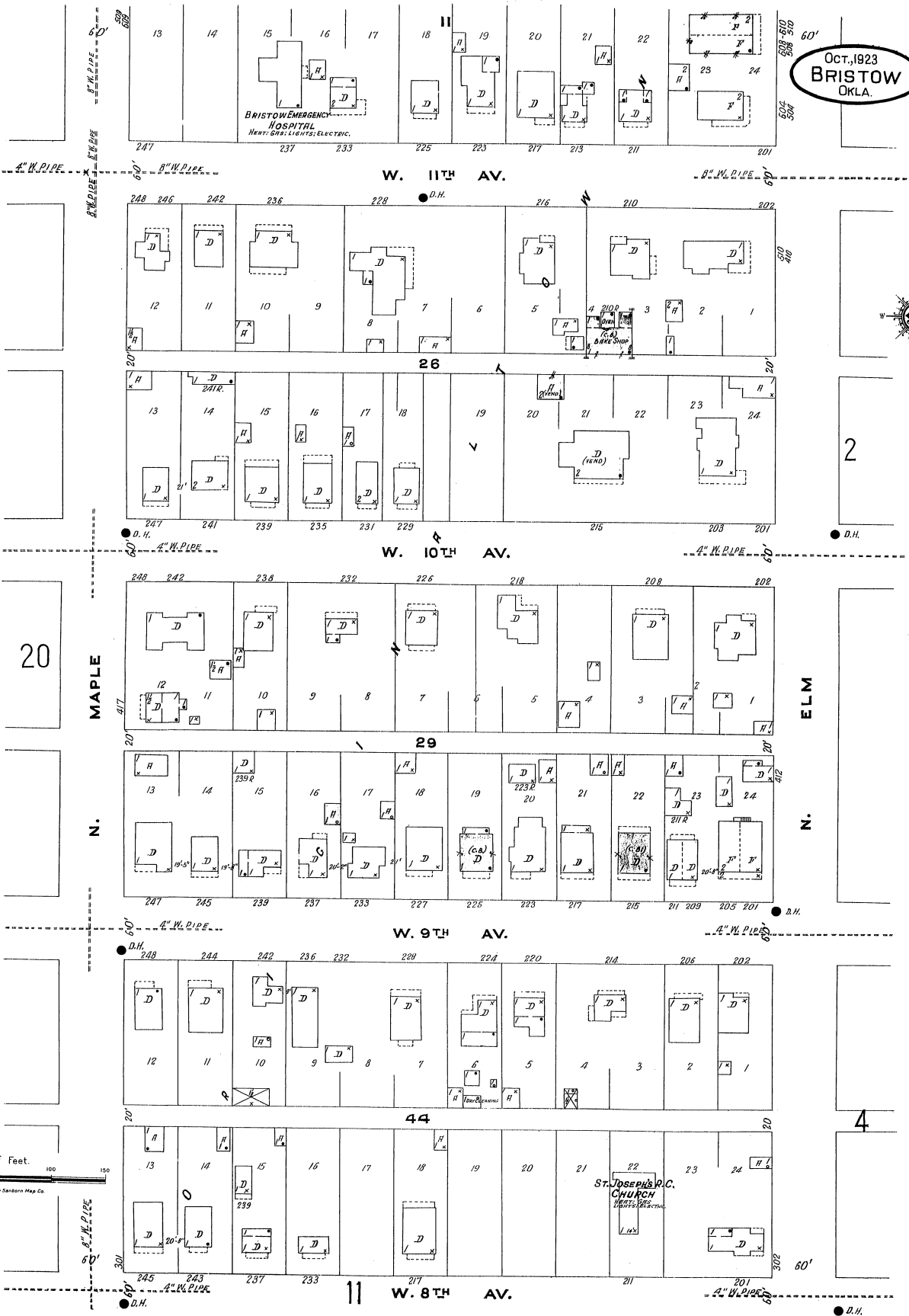

10

W. 8TH AV.

OCT. 1923  
BRISTOW  
OKLA.

E. 4TH AV.

E. 3RD AV.

E. 2ND AV.

E. 1ST AV.

MAPLE

ELM

OAK

ELM

W. 7TH AV.

W. 6TH AV.

W. 5TH AV.

12

20

15

16

MAPLE

ELM

Scale of Feet.



Copyright 1923 by the Sanborn Map Co.

BOSTON PRESBYT. CHURCH  
WHEEL STATION & 5' BRICK

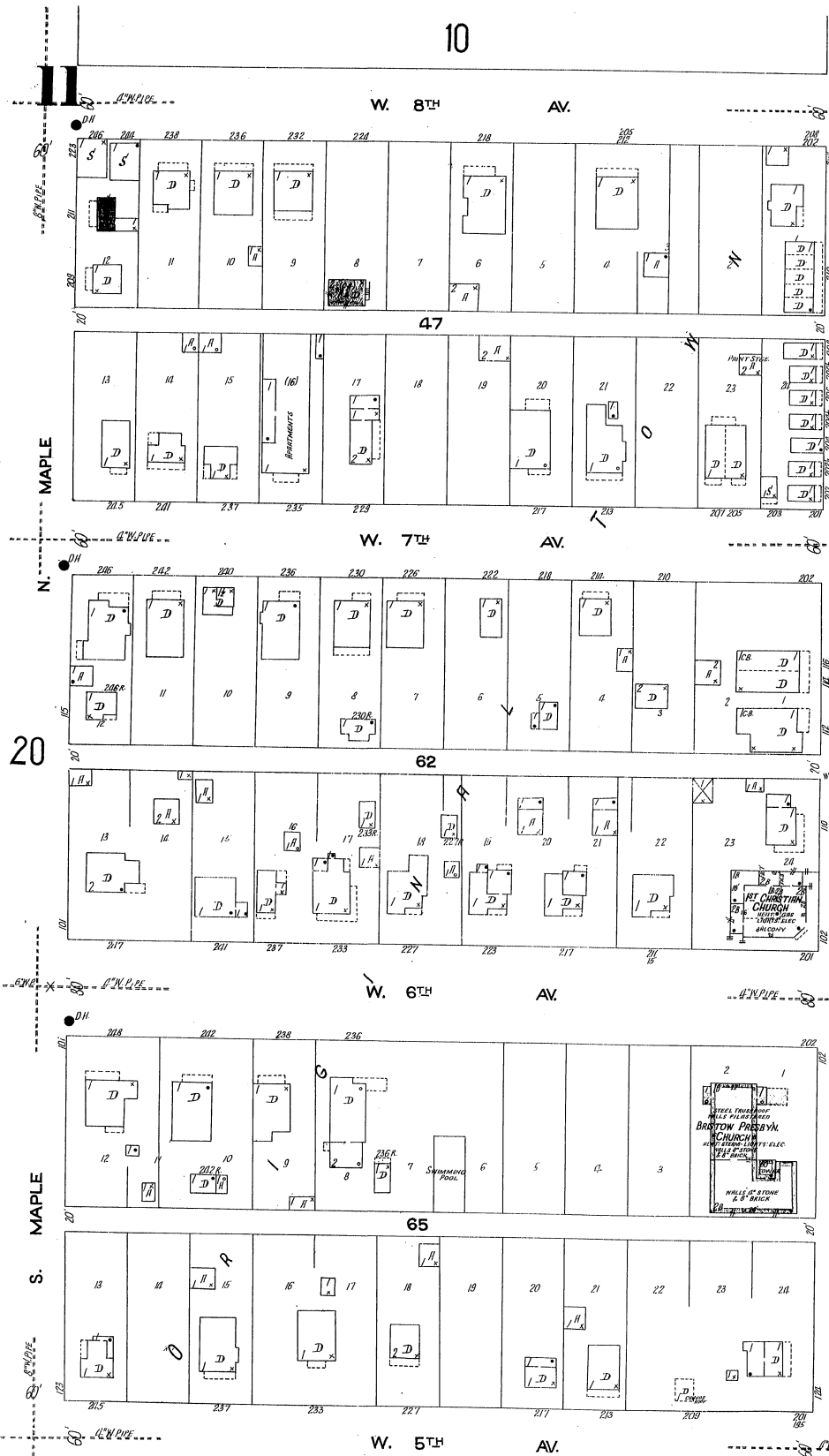
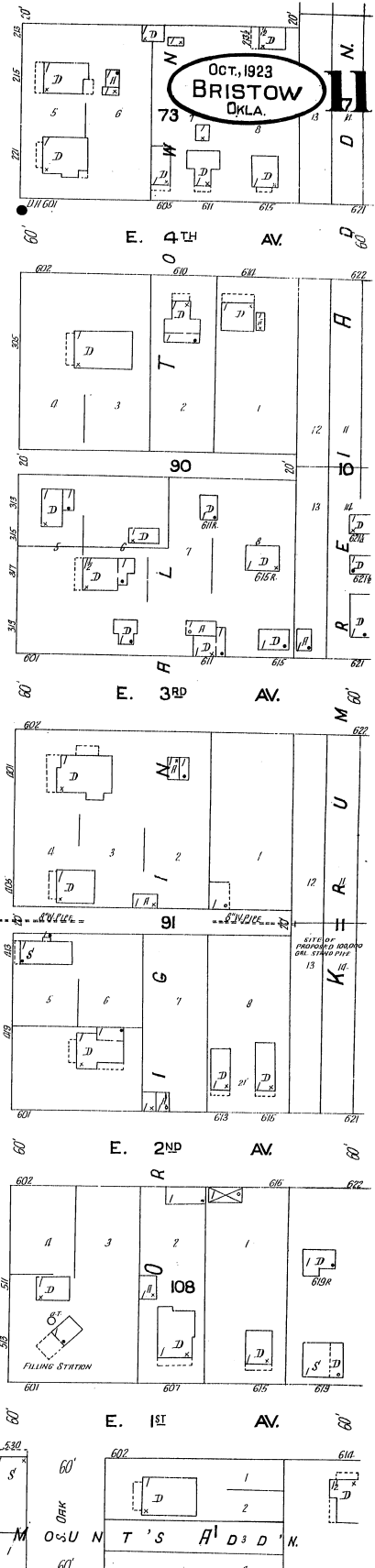



Oct., 1923  
**BRISTOW**  
 OKLA.

Scale of Feet.  
 0 50 100 150  
 Copyright 1923 by the Sanborn Map Co.

ST. L. & S. F. RY. MAIN TRACK  
 O.S. & W. RY. MAIN TRACK

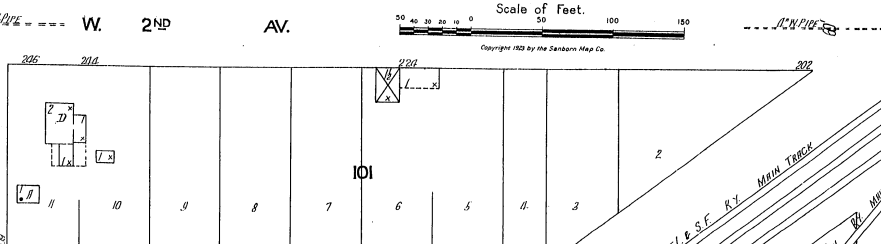
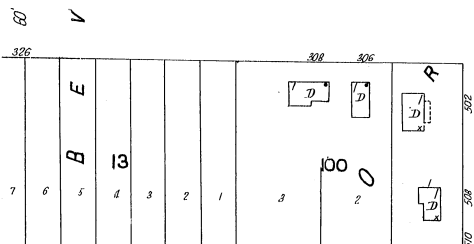
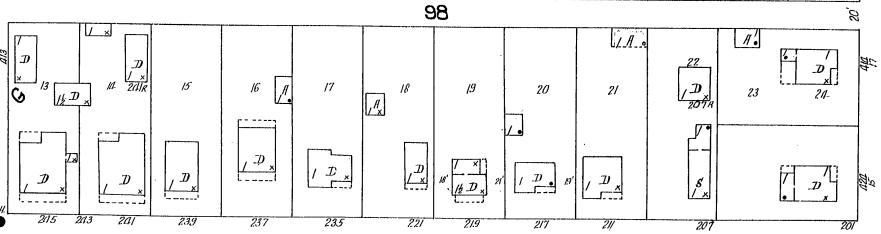
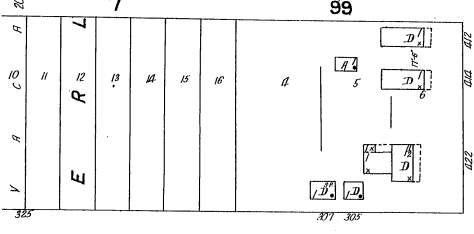
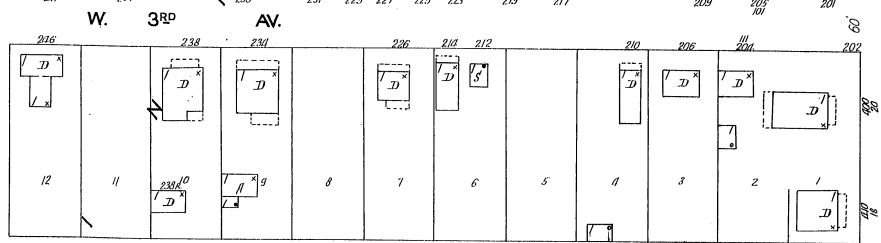
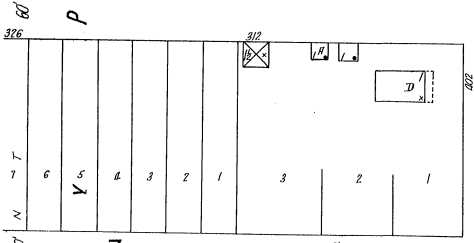
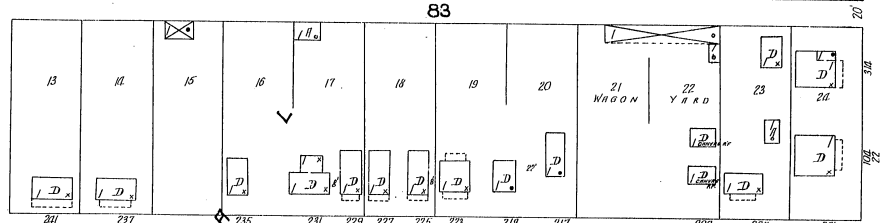
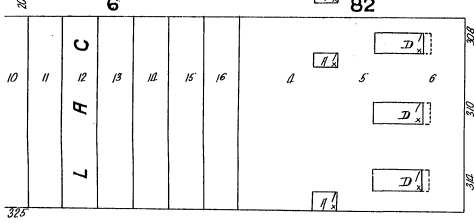
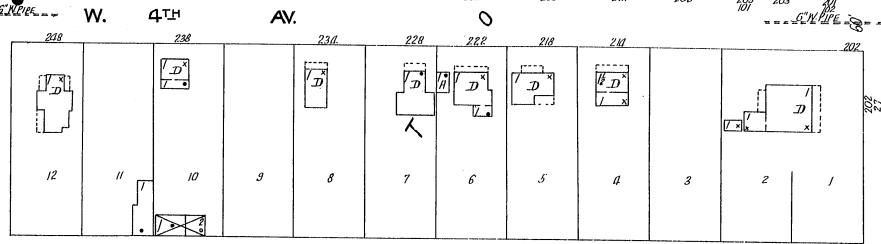
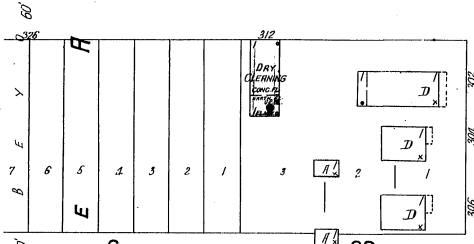
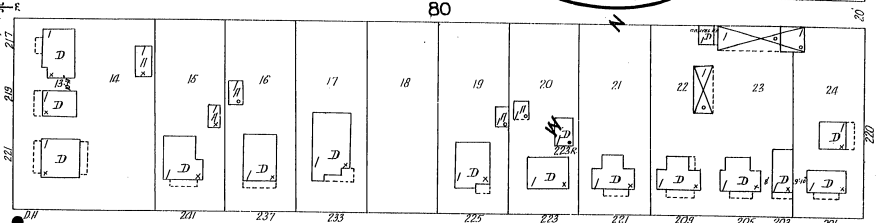
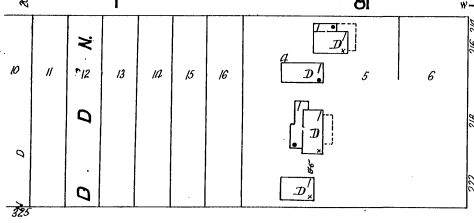
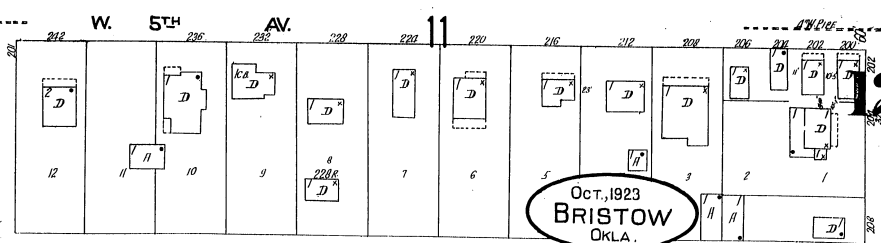
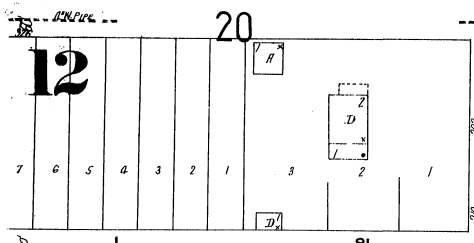

13

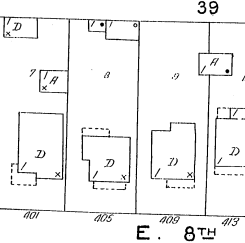
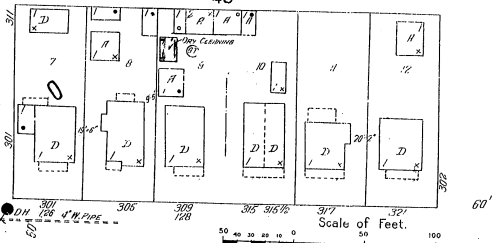
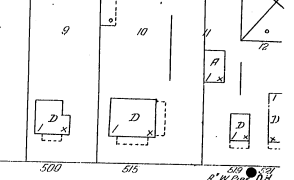
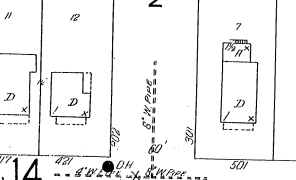
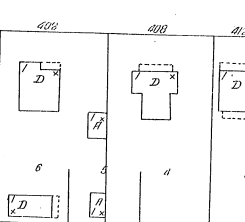
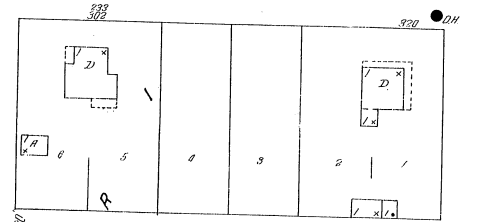
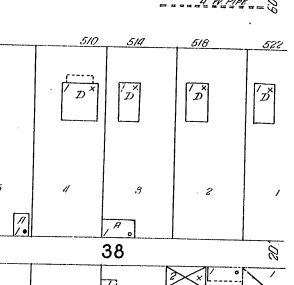
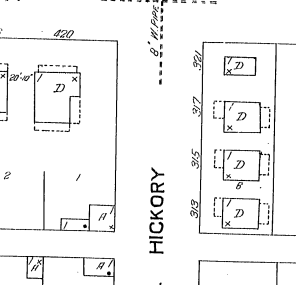
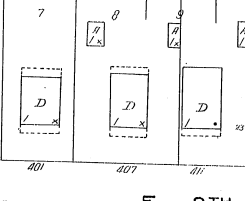
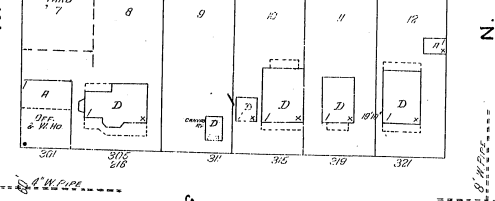
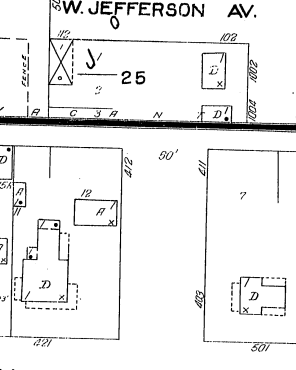
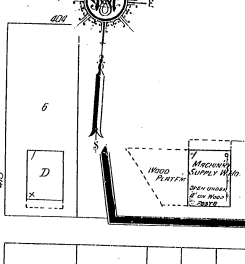
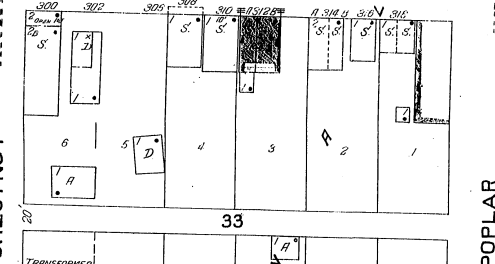
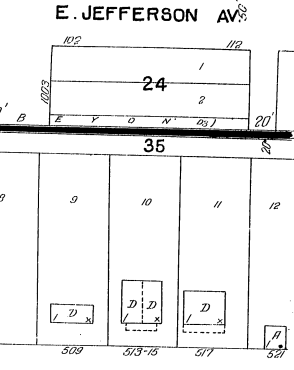
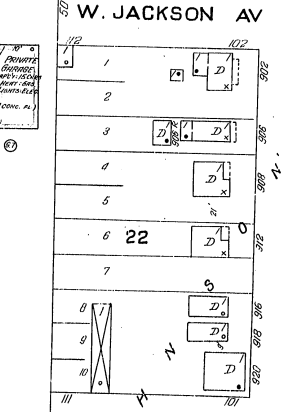
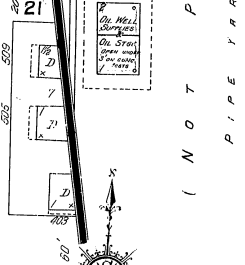
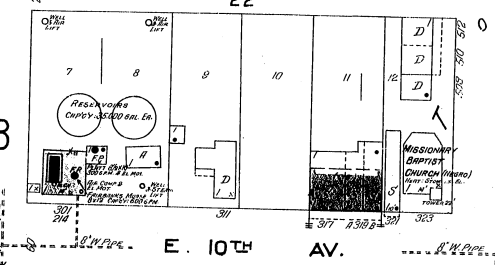
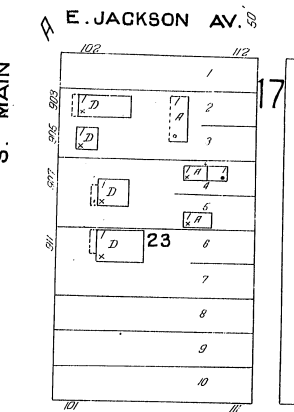
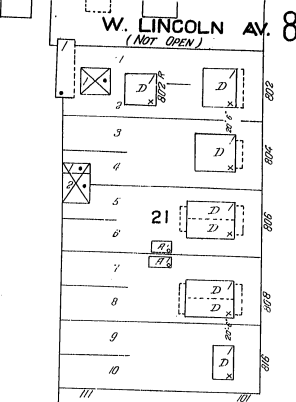
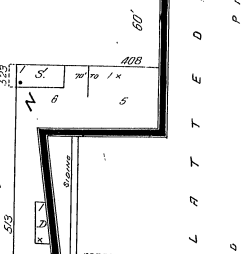
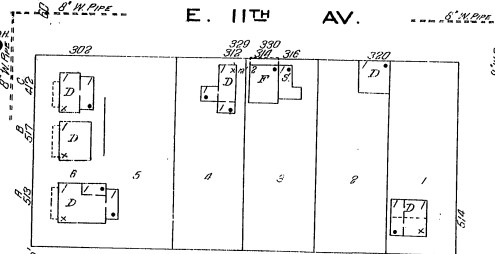
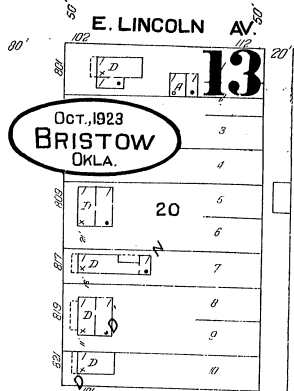
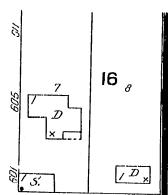
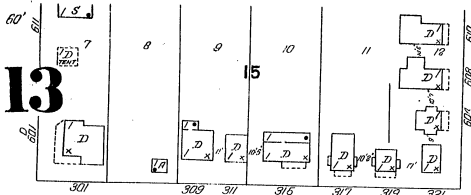

13

Oct., 1923  
BRISTOW  
OKLA. 14

E. 8TH AV.

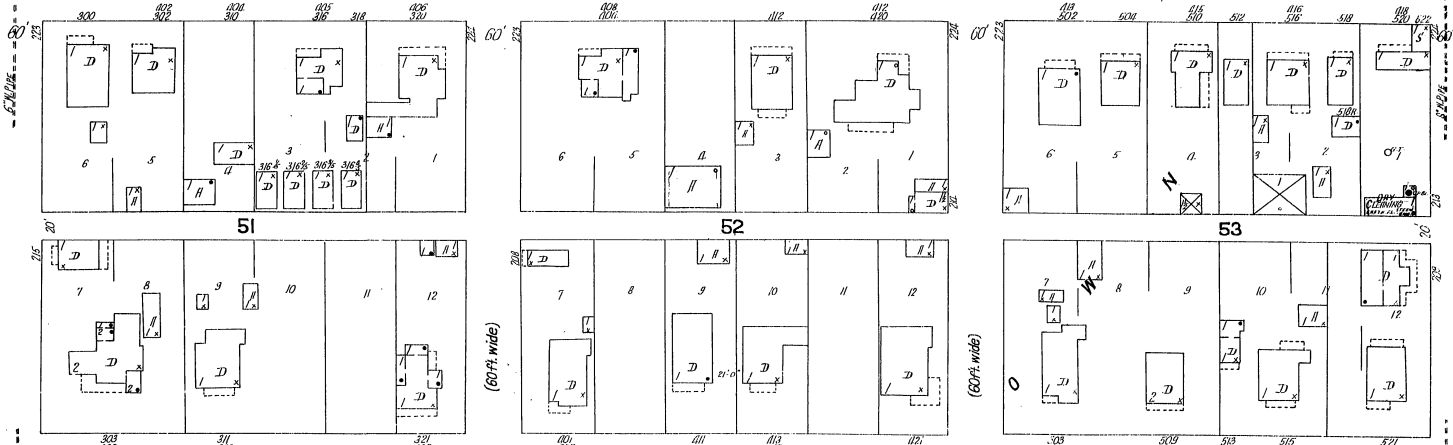

E. 7TH AV.

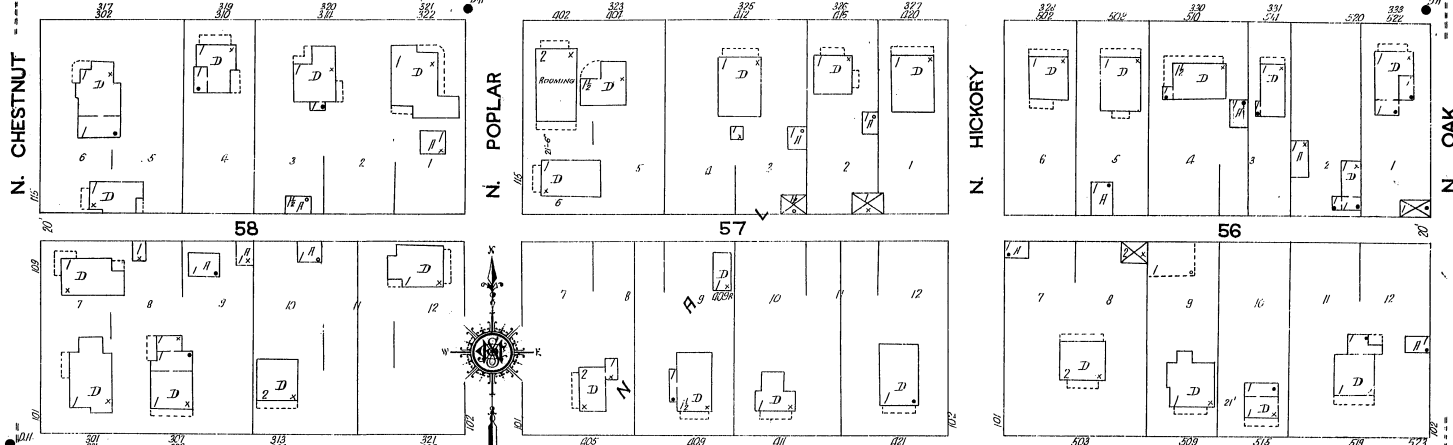

E. 6TH AV.

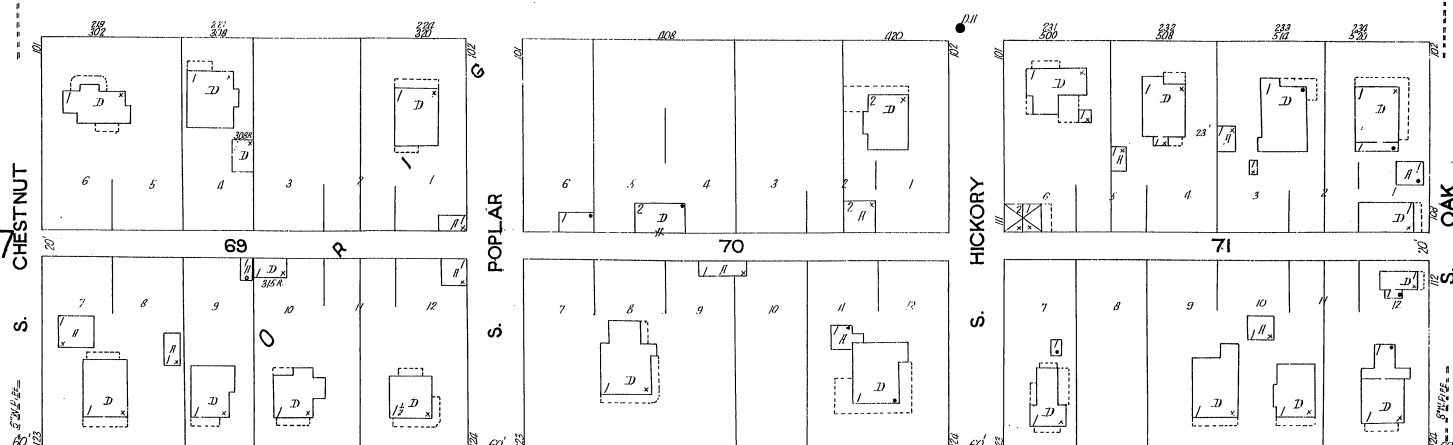

E. 5TH AV.

15

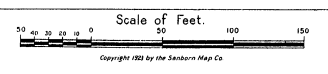

15

14

Oct., 1923  
BRISTOW  
OKLA.

15

E. 5<sup>TH</sup> AV.

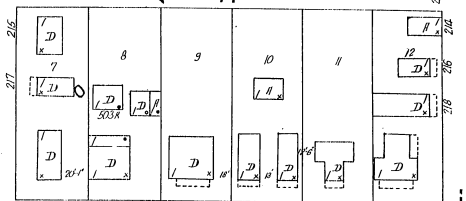
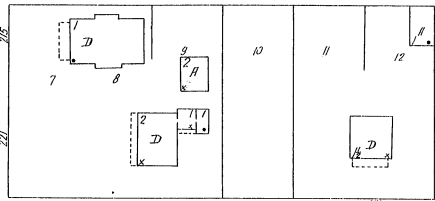
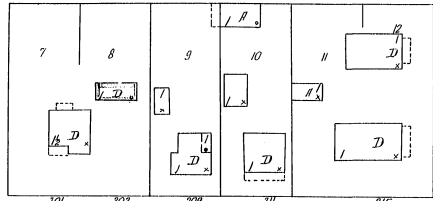
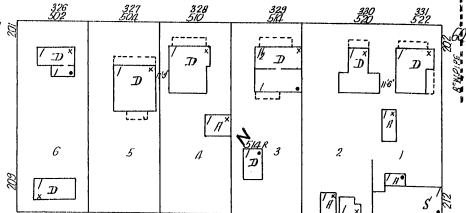
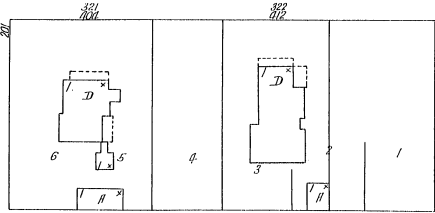
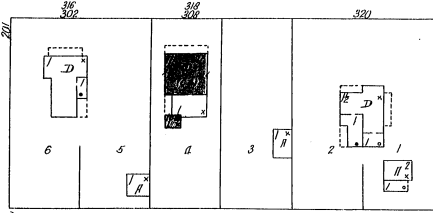

E. 4<sup>TH</sup> AV.

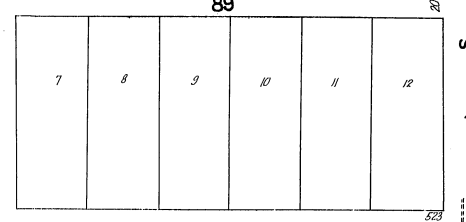
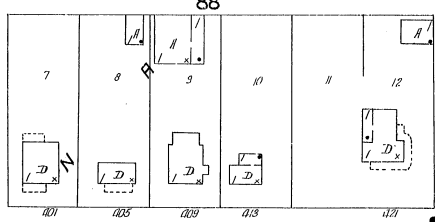
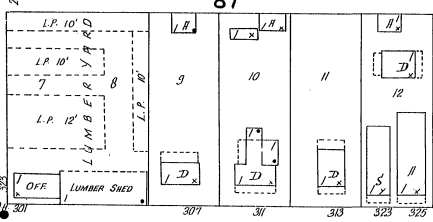
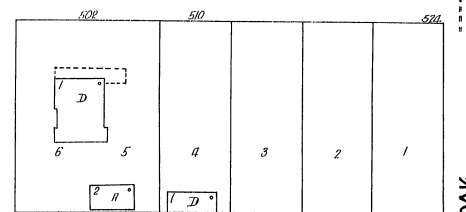
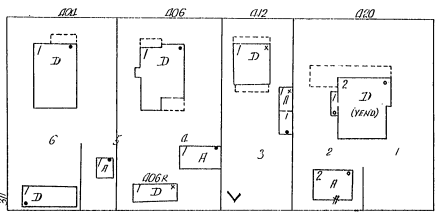
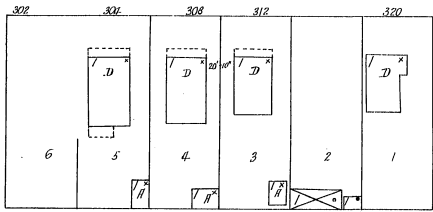

E. 3<sup>RD</sup> AV.

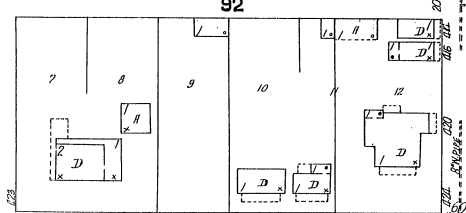
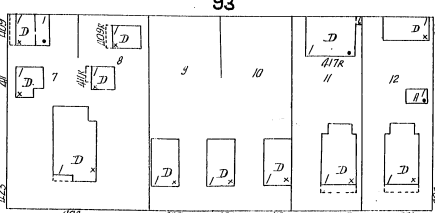
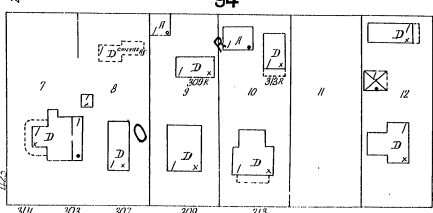
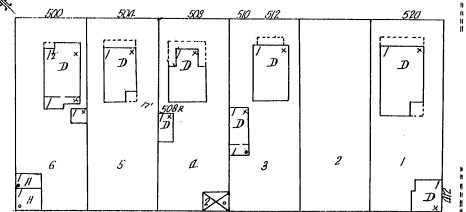
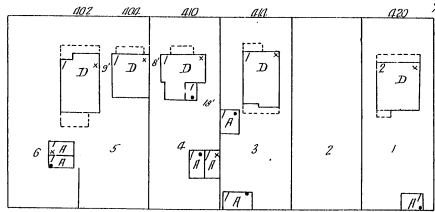
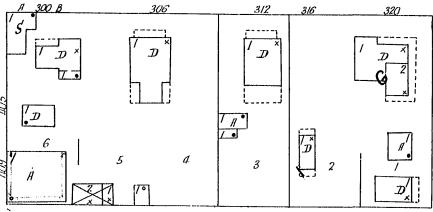

E. 2<sup>ND</sup> AV.

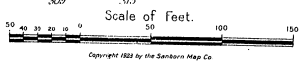

16

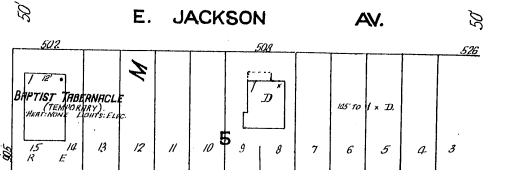
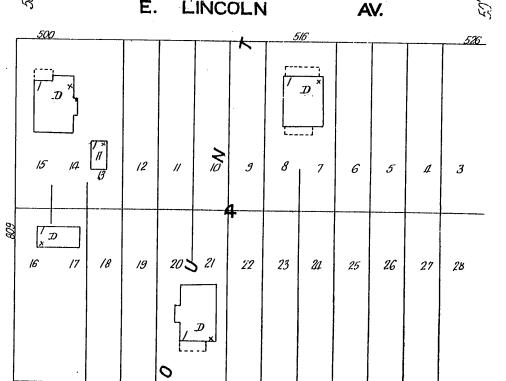
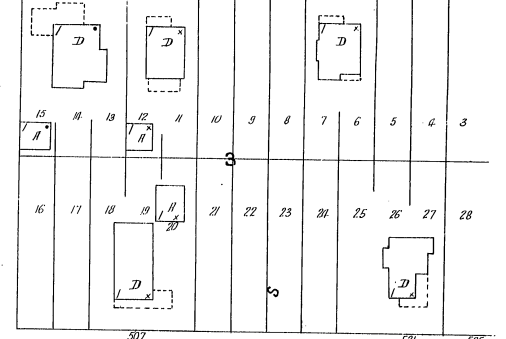
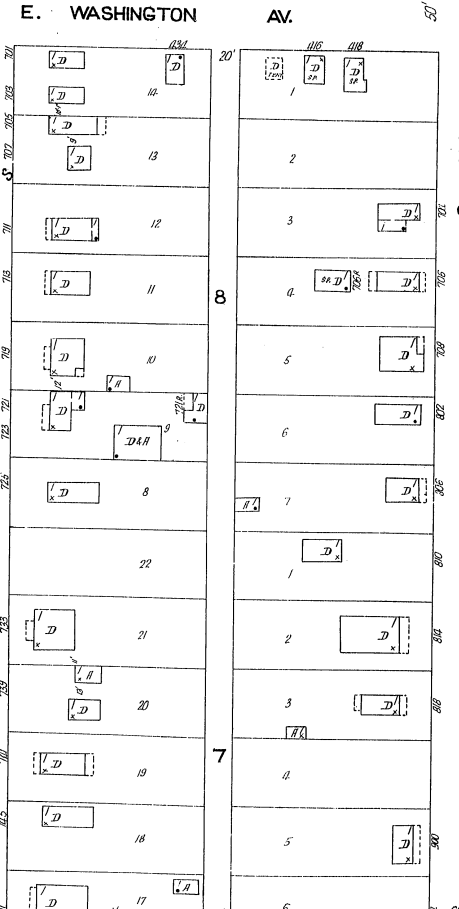
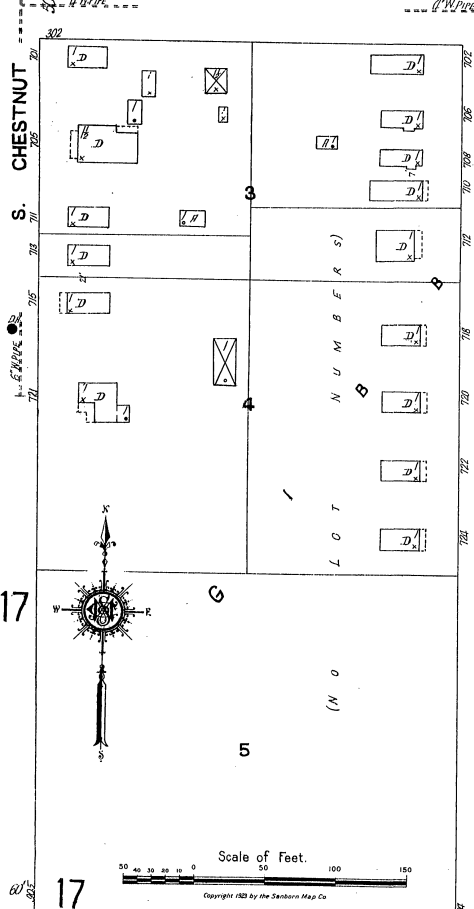
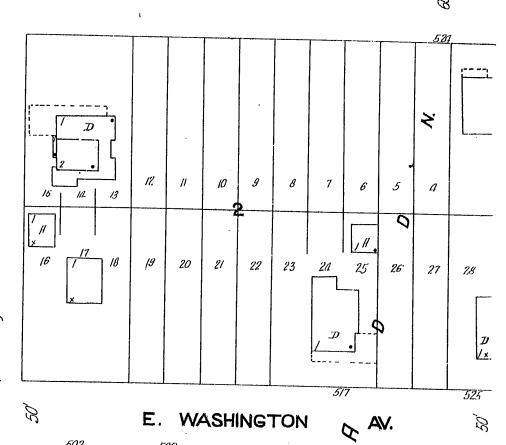
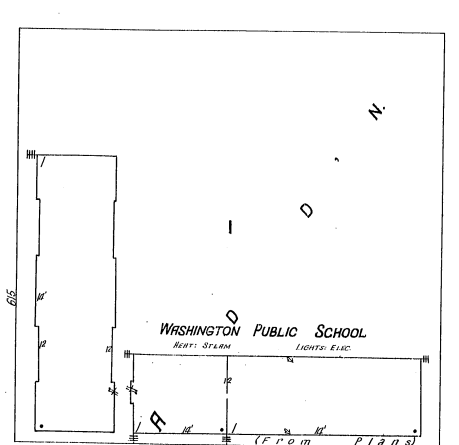
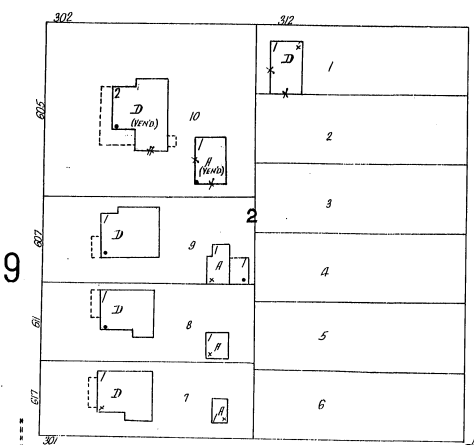
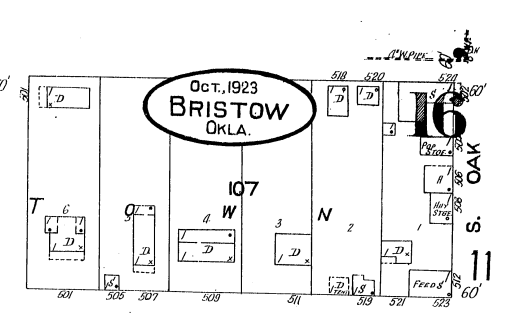
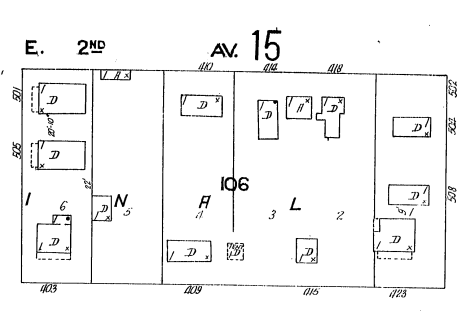
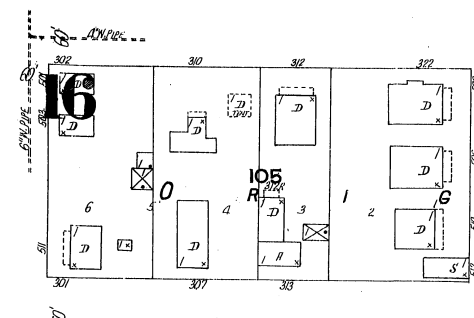

Scale of Feet.  
0 50 100 150  
Copyright 1923 by the Seaborn Map Co.



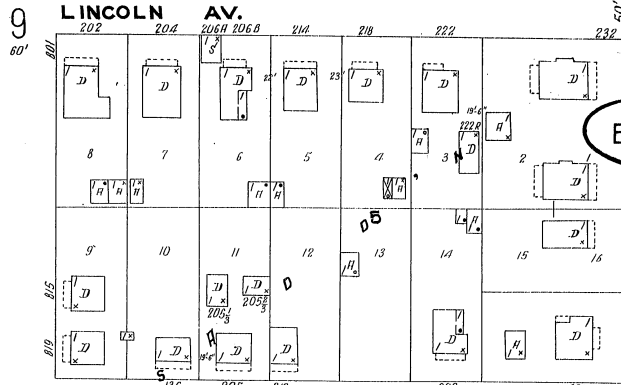
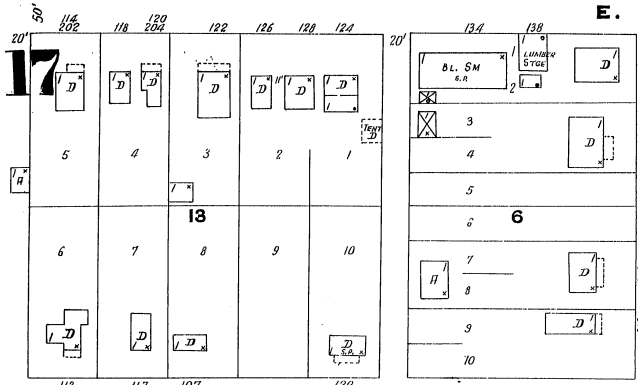

OCT. 1923  
BRISTOW  
OKLA.

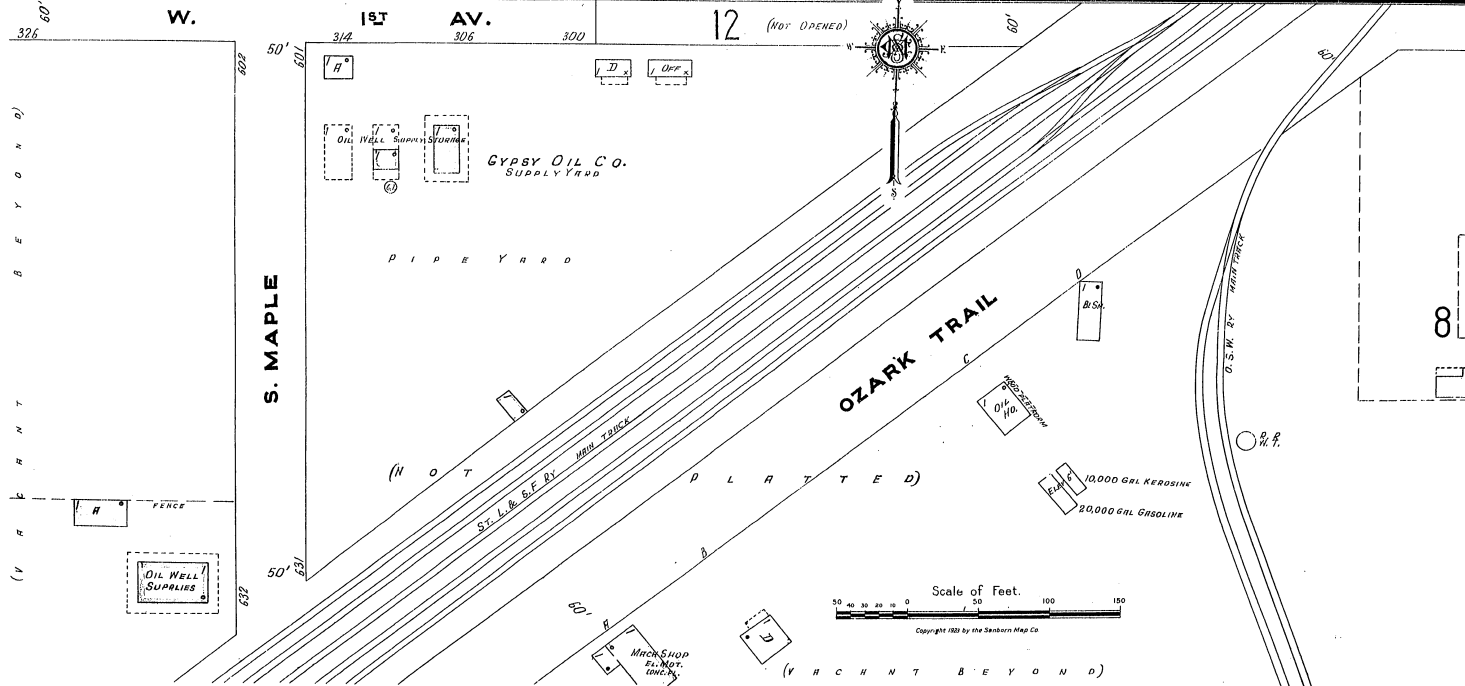
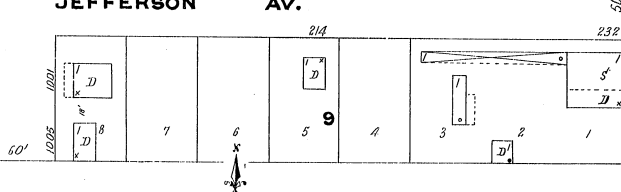
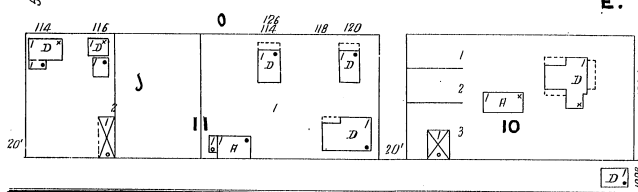
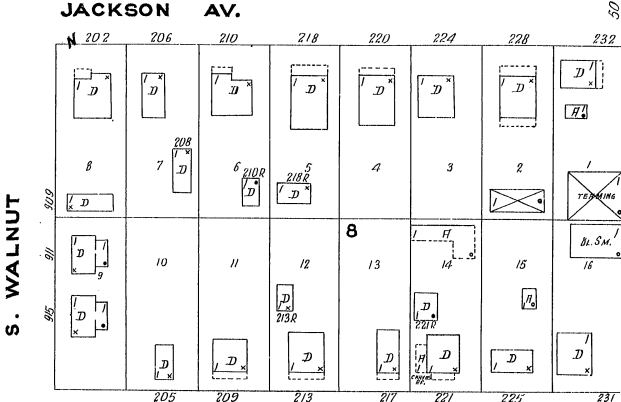
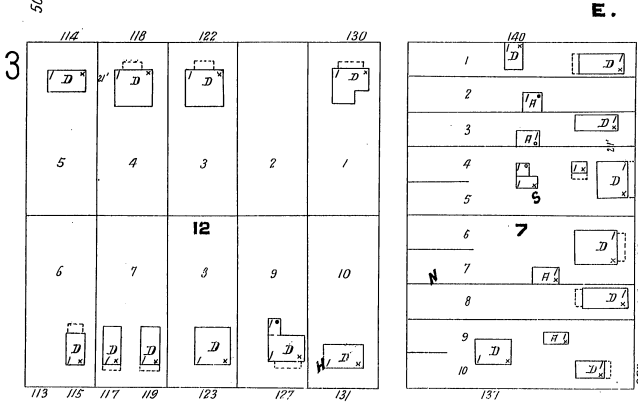

16

S. CHESTNUT

LOT 1

LOT 2

LOT 3

LOT 4

LOT 5

LOT 6

LOT 7

LOT 8

LOT 9

LOT 10

LOT 11

LOT 12

LOT 13

LOT 14

LOT 15

LOT 16

HOUSE BEYOND  
TEMPORARY FENCE

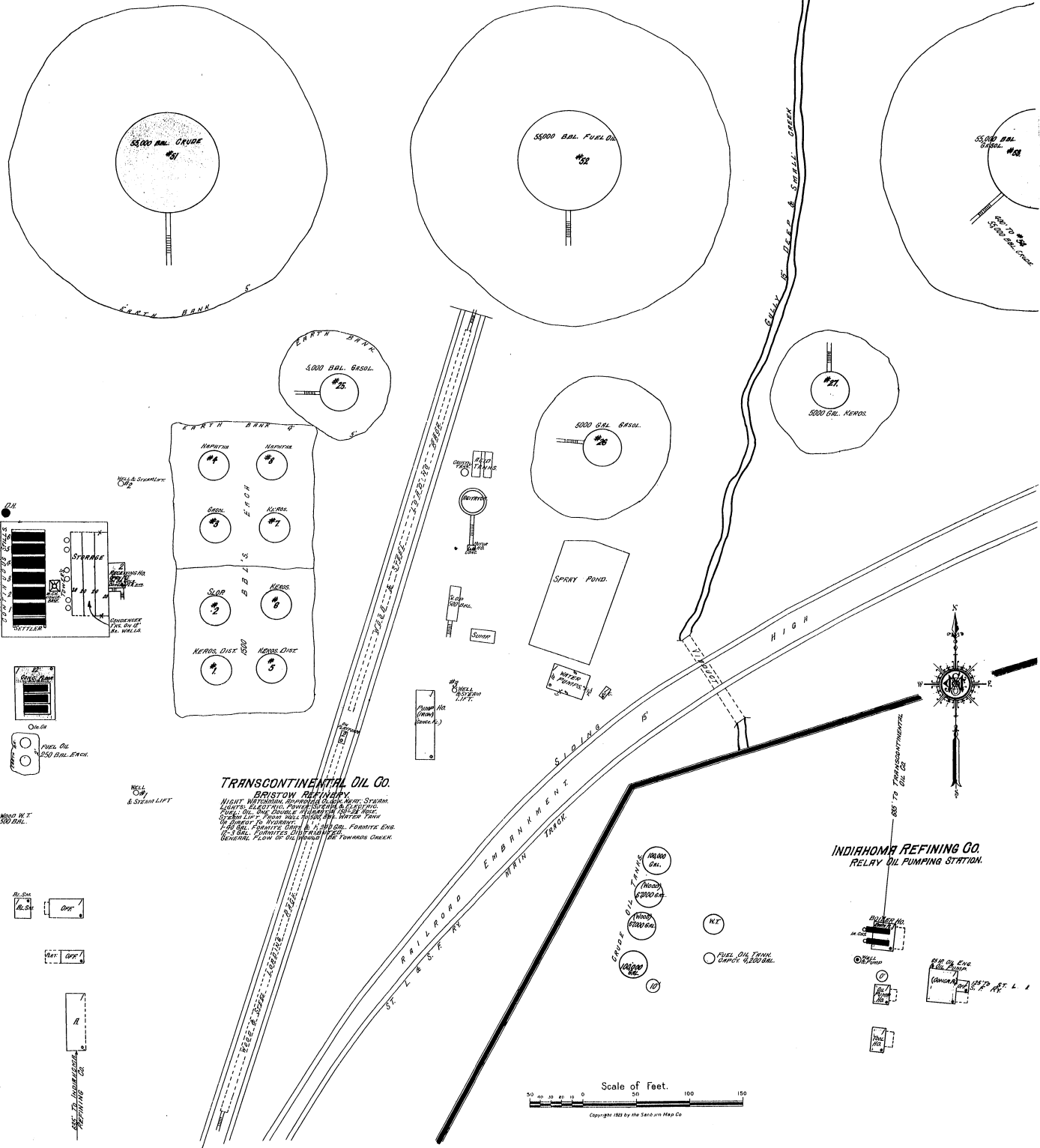



Oct. 1923  
BRISTOW  
OKLA.

SCALE 50 FT. TO AN INCH

SCALE 100 FT. TO AN INCH

STANDARD MACHINE & TOOL CO.  
NO. 100 W. 11TH ST.  
MACHINE SHOP  
WOOD TRUSS COVER FLOOR.

MACHINE SHOP  
WOOD TRUSS COVER FLOOR.

FORGE SHOP  
WOOD TRUSS COVER FLOOR.

SINCLAIR PIPE LINE CO.  
PIPE YARD

OSARK TANK

KLINGENSMITH  
PARK

PARK THEATRE  
NEXT GAS LIGHTS E.L.C.

Scale 100 Ft. to One Inch.

Copyright 1923 by the Sanborn Map Co.

GREEN COUNTY FIRE BLDG.  
SINCLAIR PIPE LINE CO.  
MANUFACTURING

OAKLAWN  
CEMETERY.

